



G-TAP A Series 1 Hardware Installation Guide

GigaVUE A Series

Product Version: 2.3.01 and above

Document Version: 1.1

Last Updated: Friday, October 11, 2024

(See Change Notes for document updates.)

Copyright 2024 Gigamon Inc. All rights reserved.

Information in this document is subject to change without notice. The software described in this document is furnished under a license agreement or nondisclosure agreement. No part of this publication may be reproduced, transcribed, translated into any language, stored in a retrieval system, or transmitted in any form or any means without the written permission of Gigamon Inc.

Trademark Attributions

Gigamon and the Gigamon logo are trademarks of Gigamon in the United States and/or other countries. Gigamon trademarks can be found at www.gigamon.com/legal-trademarks. All other trademarks are the trademarks of their respective owners.

Gigamon Inc.
3300 Olcott Street
Santa Clara, CA 95054
408.831.4000

Change Notes

When a document is updated, the document version number on the cover page will indicate a new version and will provide a link to this Change Notes table, which will describe the updates.

Product Version	Document Version	Date Updated	Change Notes
6.7	1.1	10/11/2024	This update includes bug fixes and minor cosmetic changes for improved usability and document consistency.
6.7	1.0	06/05/2024	The original release of this document with 6.7 GA.

Contents

G-TAP A Series 1 Hardware Installation Guide	1
Change Notes	3
Contents	4
G-TAP A Series 1	6
Update G-TAP A Series 1	11
Update G-TAP A Series 1 Application	11
Installation Filename Conventions	11
Update G-TAP A Series 1 Bootloader	12
Connect and Configure G-TAP A Series 1 Nodes	13
Install G-TAP A Series 1 Battery	13
Fan Operation	14
G-TAP A Series 1 with the Rack Mount Tray	14
Connect Power to G-TAP A Series 1	15
How to Use Power Supply Tray	16
Power Supply Tray Connections	16
Power Supply Tray Specifications	17
Connect Console and Mgmt Ports	18
Connect to G-TAP A Series 1 CLI	18
Serial Connections to the Console Port	19
Telnet Connections to the Mgmt Port	20
Connect to GigaVUE Using Telnet	21
Command Line Basics	21
Command History	26
Configure Network/Monitor Ports on the G-TAP A-TX	27
Configure Port Settings with the DIP Switches (G-TAP A-TX)	27
Configure Port Settings in Software (G-TAP A-TX)	29
Configuring SNMP Trap Destinations	30
SNMP Trap Events	30
How to Use G-TAP A Series 1	33
Tap a Link with G-TAP A-TX	33
To tap a link with the G-TAP A-TX:	34
Power Loss and the G-TAP A-TX	34
Blinking Link LEDs on G-TAP A-TX?	34
Tap a Link with the G-TAP A-SF	35

Power Loss and the G-TAP A-SF	35
G-TAP A-SF Transceiver Notes and Rules	36
Sample Transceiver Combinations	36
View Port Parameters	37
Connect G-TAP A Series 1 to GigaVUE Visibility Node	37
G-TAP A-SF Transceiver Details	39
G-TAP A-SF Transceiver Details	39
Supported Transceivers	39
How to Identify SFP/SFP+ Transceivers	39
SFP/SFP+ Transceiver Operating Specifications	42
Additional Sources of Information	44
Documentation	44
How to Download Software and Release Notes from My Gigamon	47
Documentation Feedback	47
Contact Technical Support	48
Contact Sales	49
Premium Support	49
The VÜE Community	49

G-TAP A Series 1

This section introduces the G-TAP A Series 1 devices, describes their features and functions, and provides an orientation to the physical layout of the G-TAP A-TX and G-TAP A-SF models. It includes the following major sections:

- [New Features in v2.3.01](#)
- [GigaVUE A Series Overview](#)

This topic covers only G-TAP A Series 1 software version 2.3.01 and above.

NOTE: Hardware revision A1 requires minimum software version 2.3.01. If you are using an earlier version of the G-TAP Series refer to the documentation for that version. For example, G-TAP A Series 1 User's Guide Version 2.2.26.

New Features in v2.3.01

Version 2.3.01 includes the following new features for the G-TAP A-TX and G-TAP A-SF:

Feature	Description
Battery Detection	Battery presence or absence is indicated.
Battery Temperature Monitoring	Battery temperature within specification is indicated.
Battery Exercise Test	Battery health is maintained by a Battery Exercise Check (BET) once per 90 days.
Battery Health Check	Battery health checks are done regularly. A new dedicated battery LED indicates the battery's state of health.
Power Over Ethernet (PoE) Pass Through	G-TAP A-TX network ports allow for PoE pass through.
BET Logging	Last four records of the BET are saved in non-volatile memory. The new show batterex command displays the records.
BET Scheduling	New CLI commands set the schedule for the BET.
Non-constant Charging	Battery charging stops when the battery is at 100% capacity. Charging starts at 95% capacity.
SNMP Traps	New traps have been added for reporting changes related to battery presence or absence and battery and board temperature out of limits.

GigaVUE A Series Overview

The G-TAP A Series 1 implements Gigamon unique *Always-On* architecture, eliminating network link downtime through the use of up to four power sources, including primary AC, DC, or Power over Ethernet (PoE) sources, and a secondary on-board battery backup. Primary power sources charge the backup battery until it is at 100 percent capacity and starts charging at 95 percent capacity, so it is ready to assume the power load in the event of a power failure on the primary sources.

G-TAP A Series 1 Features and Benefits

The G-TAP A Series 1 offers the following features and benefits:

Benefit	Description
Always-On Power Sources	Primary Power through AC, DC, or PoE (Power over Ethernet).
	Backup Battery Power is maintained for up to one hour, eliminating link renegotiation delay due to power loss.
SNMP Visibility	SNMP Traps report changes in link state, power sources, battery levels, battery state of health.
Power Supply Tray Integration	Integrates with 1U AC or DC Power Supply Trays capable of powering up to 8 fully-loaded, 3-across Rack Mount Trays (up to 24 separate taps).
Passive Monitoring and Fault Tolerance	Provides completely passive full-duplex monitoring and absolute fault-tolerance.
GigaVUE Integration	Easy integration with the full family of GigaVUE data access switches for maximum flexibility.
Supports Standard Network Speeds/Implementations	G-TAP A-TX provides connectivity for 10/100/1000 Base-T (UTP) copper Ethernet links.
	G-TAP A-SF supports SFP (SX/LX/ZX/Cu) and SFP+ (SR/LR/ER/LRM) transceivers, as well as Direct Attach Cables (SFP+ Copper) for connectivity to 10G/1G fiber and copper Ethernet links. Tap speed is determined by the external devices connected to the Network ports – both must be running at the same speed.
	See G-TAP A-SF Transceiver Notes and Rules on page 39 for more information on the types and combinations of transceivers supported for use with the G-TAP A-SF.

G-TAP A Series 1 Equipment

G-TAP A Series 1 taps are available with AC or DC power and integrate with optional rack mount trays and power supply trays, as follows:

G-TAP A Series Equipment	Power Type	Description
GTP-ATX01	AC	G-TAP A-TX Copper. Taps one 10/100/1000 Base-T (UTP) Ethernet link.
GTP-ATX02	DC	
GTP-ATX00	PST	G-TAP A-TX Copper for use with PST-GTA01 Power Supply Tray (no AC adapter).
GTP-ASF01	AC	G-TAP A-SF. Accepts fiber and copper SFP/SFP+ transceivers to tap a single 10G/1G link.
GTP-ASF02	DC	
GTP-ASF00	PST	G-TAP A-SF for use with PST-GTA01 Power Supply Tray (no AC adapter).
PST-GTA01	AC	1U Power Supply Tray. Powers up to 24 A Series taps.
PST-GTA02	DC	
GTP-ATX01-UN	AC	G-TAP A Series, Always on Copper TAP, AC Power (EU, UK, NA/JP, AU plugs).
GTP-ASF01-UN	AC	G-TAP A Series, Always on SFP/SFP+ TAP, AC Power (EU, UK, NA/JP, AU plugs).

G-TAP A Series 1 Ports and LEDs

The G-TAP A Series 1 features a consistent set of ports and LEDs across all individual models. The major differences between models are in the Network and Monitor/Tool port types – as shown in the following figures – the G-TAP A-TX uses RJ-45 copper ports while the G-TAP A-SF supports a full range of SFP, SFP+, and Direct Attach Cable transceivers.

G-TAP A-TX

Ethernet Mgmt port is used for CLI access, SNMP traps, and Power over Ethernet connections (PoE). Initial tap configuration is performed in the G-TAP CLI over the serial Console port.

Status LEDs indicate primary power source is connected, PoE, battery/board temperature in range. You can tell which power sources are connected using the Main Pwr (AC or DC) and PoE Pwr LEDs.

Batt Level LEDs show the charge level of the onboard backup battery. Each LED indicates 25 percent of the total battery charge.



Serial Console port accepts terminal connections for configuration of G-TAP A Series settings, including time, network, and SNMP settings. Speed is configurable in CLI – default settings are 8N1, 115,200 bps.

Network ports tap the link. Monitor/Tool ports feed tapped data to connected tools. The G-TAP A-TX uses RJ-45 ports with standard Link/Activity LEDs.

G-TAP A-SF

Standard Mgmt/Console ports and power LEDs all work in the same way as they do for the G-TAP A-TX shown previously.

Signal Detect LEDs for the Network and Monitor ports on the G-TAP A-SF illuminate when a signal is detected from the connected device. Note that this does not mean that a valid link is detected – it just means a signal is detected. The exception to this is when using a Direct Attach Cable. When one of these cables is connected to the G-TAP, the Signal Detect LED illuminates regardless of whether the other end of the cable is connected.

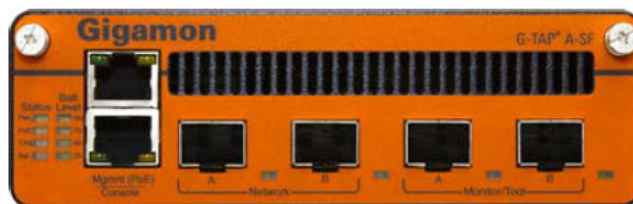

The G-TAP A-SF accepts SFP and SFP+ transceivers as well as Direct Attach Cables for the Network and Monitor/Tool ports. The transceivers in the Network A and B ports must match for successful traffic flow (for example, two SFP SR transceivers).

The transceivers in the Monitor/Tool ports must run at the same speed as those in the network ports, but they do not need to be the same medium. For example, you could have 1G SX SFP transceivers installed in both Network A and B while using 1G copper SFPs in Monitor/Tool A and B. The external devices connected to Network A and B determine the traffic speed. For more information on supported transceiver types and combinations, refer to *G-TAP A-SF Transceiver Notes and Rules* on page 39.

G-TAP A Series 1 Specifications

This section provides specifications for the G-TAP A-TX, including physical dimensions and weight, power requirements, and environmental specifications.

Physical Dimensions and Weight

Specification	Value
Width	5.5"
Height	1.75"

Depth	9.75"
Weight	3.12 lbs
Weight (Shipping)	5.0 lbs

Power Requirements

Specification	Value
AC Voltage	100-240V
AC Nominal Current Requirement	0.18A@120V
AC Frequency	47-63Hz
DC Voltage	-36 to -72VDC inputs reverse polarity protected
DC Nominal Current Requirement	0.35A@-48V

Environmental Specifications

Specification	Value
Operating Temperature	32° F to 104°F (0°C to 40°C)
Operating Relative Humidity	20% to 80%, non-condensing
Recommended Storage Temperature	-4°F to 158°F (-20°C to 70°C)
Recommended Storage Relative Humidity	15% to 85%, non-condensing
Altitude	Up to 15,000ft. (4.6km)

Update G-TAP A Series 1

This section describes how to update G-TAP A Series 1 devices. It includes the following sections:

- [Update G-TAP A Series 1 Application](#)
- [Update G-TAP A Series 1 Bootloader](#)

Update G-TAP A Series 1 Application

Update the G-TAP A Series 1 with the install command. The install command downloads an installation file stored on a specified TFTP server over the Mgmt port and applies it to the system. Use the following procedure:

1. Copy the installation file for the G-TAP A Series 1 to the root directory of your TFTP server.
2. Log in to the CLI of the system to be updated.
3. Use the install “filename” tftp_server_ip command to download and install the software. For example, the following command installs the gta2007.bin file from the TFTP server at 192.168.1.10:

```
install gta2007.bin 192.168.1.10
```

4. Use the reboot command and select whether to perform a Warm reboot (Option 1) or a Cold reboot (Option 2).

Consult the Release Notes for your software to determine which type of reboot to perform. Most upgrades require only a Warm reboot. The upgrade to Release v2.3.00 requires only a Warm reboot.

NOTE: The Network and Monitor/Tool ports bounce during a cold reboot but not during a warm reboot.

Installation Filename Conventions

The following table summarizes the filename conventions for G-TAP A Series 1 installation files.

G-TAP A Series Installation Filename Conventions

G-TAP A-TX	gtaxxxx.bin
G-TAP A-SF	gtbxxx.bin
Bootloader	aloaderxxx.bin

Update G-TAP A Series 1 Bootloader

You use the install command with the -al argument to install updated bootloader software for the A Series 1. Use the following procedure if your upgrade requires updated bootloader software:

1. Copy the bootloader installation file for the G-TAP A Series 1 to the root directory of your TFTP server.
2. Log in to the CLI of the system to be updated.
3. Use the install -al "filename" tftp_server_ip command to download and install the software. For example, the following command installs the aloader204.bin file from the TFTP server at 192.168.1.10: **install -al aloader204.bin 192.168.1.10**
4. Use the reboot command to restart the system and select whether to perform a Warm reboot (Option 1) or a Cold reboot (Option 2).

Consult the Release Notes for your software to determine whether a bootloader upgrade is required and, if so, which type of reboot to perform. Most bootloader upgrades require a Cold reboot.

NOTE: The Network and Monitor/Tool ports bounce during a cold reboot but not during a warm reboot.

Connect and Configure G-TAP A Series 1 Nodes

This section describes how to assemble, connect, and configure the G-TAP A Series 1 devices. It includes the following major sections:

- [Install G-TAP A Series 1 Battery](#)
- [G-TAP A Series 1 with the Rack Mount Tray](#)
- [Connect Power to G-TAP A Series 1](#)
- [How to Use Power Supply Tray](#)
- [Connect Console and Mgmt Ports](#)
- [Command Line Basics](#)
- [Configure Network/Monitor Ports on the G-TAP A-TX](#)
- [Configuring SNMP Trap Destinations](#)

Install G-TAP A Series 1 Battery

The backup battery provides a failsafe in case all primary power sources (AC, DC, or PoE) are unavailable. Primary power sources constantly charge the backup battery until it is a 100% capacity and starts charging at 95% capacity, so it is ready to assume the power load in the event of a power failure on the primary sources.



The G-TAP A Series 1 is shipped with its backup battery uninstalled. If the battery is not installed, some packet loss might occur during a change in input power.

NOTE: You can install the battery GTA10 by Excell without disconnecting any existing power connections.

Use the following instructions to install the backup battery:

To Install the backup battery:

Steps	Illustration
<ol style="list-style-type: none"> 1. Locate the backup battery in your product shipment. 2. Place the tap upright on a flat surface. 3. Loosen the thumbscrews on the battery cover (shown at right) and remove it. 	 <p>Battery cover screw</p> <p>Battery cover screw</p> <p>G-TAP A-TX shown; G-TAP A-SF does not include the DIP switches.</p>

4. Disconnect the fan connector.	
5. Orient the battery so that the battery connector is on the bottom.	
<p>6. Slide the battery into the battery slot.</p> <p>7. Reconnect the fan connector. Reinstall the battery cover, being careful not to touch the fan. The fan may be in operation during replacement. Refer to Fan Operation on page 17.</p> <p>8. If a primary power source is not already connected, connect one now using the instructions in “Connecting Power to the G-TAP A Series” on page 4.</p>	

CAUTION: ALWAYS USE BATTERIES PROVIDED BY GIGAMON. RISK OF EXPLOSION IF BATTERY IS REPLACED BY AN INCORRECT TYPE.

When a battery is installed to a G-TAP A Series 1 module for the first time, it is recommended that you do a manual battery exercise cycle to ensure that battery management is set to the normal condition. The battery exercise cycle is defined as follows:

1. With battery installed in unit, charge the battery for 12 hours or until battery is full.
2. Discharge the battery by unplugging the external power resource for 3 hours or until the battery is empty.
3. Plug in the external power resource.

The G-TAP A Series 1 module is ready for use.

NOTE: When a battery is connected to the DW01+ for the first time, it may not enter the normal condition (discharge may not be enabled). In this case, short the CS and VSS pins or connect to a charger to restore to the normal condition.

Fan Operation

The G-TAP A-TX fan operates if the main board temperature is equal to or greater than 50C (10%+/-) and/or the battery temperature is equal to or greater than 50C (10%+/-).

G-TAP A Series 1 with the Rack Mount Tray

G-TAP A Series 1 taps can be used either standalone or installed in the optional, three-across, 1U rack mount tray. Install taps in the rack mount tray as follows:

1. Select an open bay from one of the three bays in the front of the rack mount tray and remove its protective slot cover.
2. Gently slide the module into the target slot until the faceplate is flush with the chassis.
3. Tighten the thumbscrews on the module faceplate.
4. The rack mount tray installs in a standard 1U rack space using the provided hardware. You can install in two-post or four-post racks with a minimum width of 17.75”.

Connect Power to G-TAP A Series 1

Supply power to the G-TAP A Series 1 using at least one of the primary power sources listed in [Connect and Configure G-TAP A Series 1 Nodes](#). [Connect and Configure G-TAP A Series 1 Nodes](#) shows the location of the power connections. All primary power sources trickle charge the backup battery, ensuring a full charge in the event of power loss to primary sources.

The chassis ground screw connects here. Connect grounding wire with spade lugs here and to earth ground.

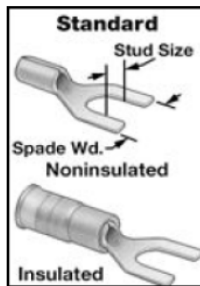

The -48v DC version of the G-TAP A Series includes a DC power supply for standalone DC-powered implementations. The terminals are clearly labeled for easy connection to a DC power source.



This picture shows the G-TAP A-TX. The G-TAP A-SF does not include the DIP switches.

Primary and secondary AC power modules are always available. Supply power using either the provided AC adapter or pigtail connectors from one of the Power Trays. Both the AC and DC Power Trays connect to the PRI/SEC AC connectors on the tap.

The backup battery is installed behind this cover. Primary power sources provide a constant trickle charge, ensuring an hour of backup battery power in the event of an outage.

Primary Power Sources

Power Source	Connection Instructions
AC	<ol style="list-style-type: none"> a. Connect the supplied AC power adapter to a grounded 110-240V power source and the PRI connector on the rear of the tap. b. Twist the connector to lock it in place on the tap. c. Connect an optional second adapter to the SEC connector as a backup. AC adapters supply 5.3V/3A.

DC	<ol style="list-style-type: none"> Connect the positive and negative power cables to the screw terminals using either a Phillips screwdriver or the twist-lock feature. Connect the neutral wire to the 0V (RTN) connector on the DC power source. Connect the negative wire to the -48v connector on the DC power source. Connect grounding wire with spade lugs to the ground screw on the tap and earth ground. <ul style="list-style-type: none"> Ground Screw – #8 Panhead, Phillips-drive, Exterior SEM screw with 32x1/2" L dimensions. Ground Wire/Lugs – Standard Wire 14-16 (AWG); Stud Size #6 (0.138"); Spade Width 0.32"
PoE	<p>Connect the Mgmt port to a PSE device conforming to either the Type 1 (802.3af) or Type 2 (802.3at) Power over Ethernet implementations.</p> <p>Type 1 requires CAT3 or higher Ethernet cable; Type 2 requires CAT5 or higher.</p> <div style="border: 1px solid black; padding: 5px; background-color: #e6f2ff;"> <p>NOTE: PoE is used as a backup power source if either AC or DC power is connected.</p> </div>
AC Power Tray	<ol style="list-style-type: none"> Start by supplying separate power sources to Power Sources A and B in the Power Supply Tray. Each Power Source has two inputs for a total of four in the tray.
DC Power Tray	<ol style="list-style-type: none"> Next, connect the provided male-to-male pigtail cables from the A1-A12 and B1-B12 connectors at the rear of the unit to the PRI/SEC connectors on individual taps. Twist the cables to lock them. For redundant power, connect a tap's PRI connector to Power Source A and the SEC connector to Power Source B (for example, A1/B1). Refer to Power Supply Tray Connections for details.

How to Use Power Supply Tray

The optional PST-GTA0x Power Supply Tray can be used to power the G-TAP A Series 1 in a Restricted Access Location. A single 1U Power Supply Tray provides 24 power connections (A1-12 from Power Source A; B1-12 from Power Source B). This lets you supply redundant power to 12 separate taps (four fully-loaded RMT-GTA03 trays). Separate AC and DC models are available to match your data center needs. [Connect and Configure G-TAP A Series 1 Nodes](#) shows the front view of the power supply tray. [Connect and Configure G-TAP A Series 1 Nodes](#) shows the review of the power supply tray.

Power Supply Tray Connections

Make Power Supply Tray connections as follows:

1. Rack-mount the unit. If you removed the power supply modules while rack-mounting the unit, reinstall them.
2. Connect the chassis to earth ground. The correct ground screws are included with the unit (8-32x5/8" L, Phillips, Pan Head, Exterior SEM screw). See the diagram above for the location of the ground screws.
3. Make sure the power supply modules are installed in the chassis and supply separate power sources to Power Sources A and B in the Power Supply Tray. Each Power Source has two inputs for a total of four in the tray.

DC UNITS:For each DC power supply:

- a. Connect ground wires to the DC power supplies.
- b. Connect the positive and negative power cables to the DC power supply screw terminals using a Phillips screwdriver. The top connector on the DC power supply is the 0V connector; the bottom connector on the DC power supply is the -48V return connector
- c. Connect the neutral wire to the 0V (RTN) connector on the DC power source.
- d. Connect the negative wire to the -48v connector on the DC power source.
- e. Once connected, the power tray and G-TAP A are considered PERMANENTLY CONNECTED EQUIPMENT. For safety compliance, you must:
 - Incorporate a readily accessible disconnect device external to the DC power supply, such as a double pole switch or a circuit breaker.
 - Have an overcurrent protective device. This is provided by the DC power supply, which contains a 10A fuse.
4. Connect the provided male-to-male pigtail cables from the A1-A12 and B1-B12 connectors at the rear of the unit to the PRI/SEC connectors on individual taps. Twist the cables to lock them.
5. For redundant power, connect a tap's PRI connector to Power Source A and the SEC connector to Power Source B (for example, a single G-TAP A Series 1 could use A1-PRI and B1 - SEC for redundant power).

Power Supply Tray Specifications

The power specifications for the PST-GTA0x power supply tray are as follows:

Specification	PST-GTA01 (AC)	PST-GTA02 (DC)
Input	100V-240V AC, 4-2A, 47-63HZ	-40V to -72 VDC, 10-5 A
Nominal Input Current	3 A @ 110V AC	6.4 A @ -48VDC
Nominal Power Consumption	337 W	308 W
Nominal BTU Output	1149 BTU/hr	1050 BTU/hr

Connect Console and Mgmt Ports

G-TAP A Series 1 taps include both a serial Console port and a 10/100 Ethernet Mgmt port ([Connect and Configure G-TAP A Series 1 Nodes](#)).

To connect the Console and Mgmt ports:

1. Connect the RJ45 end of the provided DB9-to-RJ45 serial cable to the Console port of the G-TAP.
2. Connect the DB9 end of the cable to a COM port on a PC or terminal server.
3. Use a standard Ethernet cable to connect the Mgmt port to a network with access to a destination station for SNMP traps.

NOTE: Autonegotiation is always enabled on the Mgmt port of the G-TAP A Series 1 node. To avoid duplex mismatches, make sure autonegotiation is also enabled on the network port to which you connect the Mgmt port.

Each power connector has a pigtail connector and a replaceable 125VAC/5A, 5x20mm, Fast-Blo fuse.
To provide redundant power, connect a tap's PRI connector to Power Source A and the SEC connector to Power Source B (for example, A1-PRI and B1-SEC).



The chassis ground screws are at the rear of the unit. Connect grounding wire here and to earth ground.

- Use the top-left and top-right screws to exit to the left of the chassis.

- Use the top-right and bottom-right screws to exit below the chassis.

Connect to G-TAP A Series 1 CLI

You perform the initial configuration of the G-TAP A Series 1 node over the **Console** port. Once you have used the **Console** port to configure the **Mgmt** port's network properties and enabled Telnet, you can configure the tap remotely over the **Mgmt** port's network connection. The same commands are available in the command-line interface regardless of whether you use the **Console** or **Mgmt** port.

NOTE: You must configure the Mgmt port to send SNMP traps and download application images. These features are not available over the Console port.

Type of Configuration Sessions	Instructions
Local connections with a serial connection to the Console port.	Serial Connections to the Console Port

Remote connections with a Telnet connection to the **Mgmt** port.

[Telnet Connections to the Mgmt Port](#)

Serial Connections to the Console Port

A serial connection to the console port is made through a terminal emulation program. Either PuTTY or Tera Term is recommended.

Use the following procedure to establish a configuration session with the G-TAP A Series 1 over the Console port.

To access the command-line interface over the Console port:

1. Make the basic power and Console cable connections described in previous sections.
2. Start the terminal emulator (either PuTTY or Tera Term.) Go to the serial connection settings in the terminal emulator.
3. Select the COM port connected to the Console cable from. For example, COM1.
4. Configure the port settings for the Console connection as shown in the following table and Configuring Serial Console Settings in Tera Term.

Setting	Value
Bits per second	115,200
Data bits	8
Parity	None
Stop bits	1
Flow control	none
Password	root123

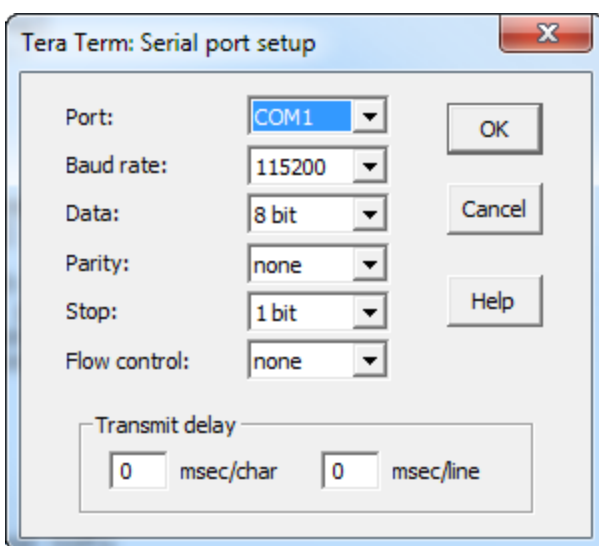

5. Click **OK** and the terminal session begins.
6. You may need to press **Enter** a few times before you see the login prompt. Enter the default password of root123. It is a good idea to use the passwd command to change the default after your first login.

The **G-Tap>** prompt appears, giving you access to the built-in command-line interface. See [Connect and Configure G-TAP A Series 1 Nodes](#) for information on getting started with the CLI.

Telnet Connections to the Mgmt Port

Use the following procedures to establish a Telnet session with the G-TAP A Series 1 node over the Mgmt port.

As shown in [Connect and Configure G-TAP A Series 1 Nodes](#), the **Mgmt** port is a standard RJ45 10/100 Ethernet port located in the upper left corner of the G-TAP A Series 1 node.

Configure Network Settings on the Mgmt Port

Before you can connect remotely to the **Mgmt** port, you must configure its IP settings over the Console port using the following procedure:

To configure the settings on the Mgmt port:

1. Connect locally to the GigaVUE command-line interface (CLI) over the **Console** port using the instructions in [Connect and Configure G-TAP A Series 1 Nodes](#).
2. Use the config command to set network parameters for the Mgmt port. For example, the following command configures the port with a static IP address of 192.168.1.55:

```
config dhcp 0 ipaddr 192.168.1.55 subnetmask 255.255.255.0
```

These commands could also be issued separately:

```
config ipaddr 192.168.1.55 subnetmask 255.255.255.0config dhcp 0
```

Alternatively, you could use config dhcp 1 to obtain an IP address from a DHCP server automatically.

3. Use the config gateway command to set the default gateway. For example:

```
config gateway 192.168.1.1
```

4. Enable Telnet on the **Mgmt** port with the following command:

```
config telnet <0 | 1>
```

5. Reboot the G-TAP A Series with the reboot command to apply your changes, then ping the Mgmt port from another station to verify that the network parameters were applied as expected.

Connect to GigaVUE Using Telnet

When Telnet is enabled, you can use any compliant Telnet client to connect to the command-line interface remotely. For example, to connect using the Telnet client provided with Microsoft Windows:

1. Open a command prompt window and type Telnet.
2. Type open <Mgmt Port IP Address>.
3. Supply the G-Tap Login Password (by default, root123).

[Connect and Configure G-TAP A Series 1 Nodes](#) shows a sample Telnet connection to a G-TAP A Series node using the free TeraTerm client.

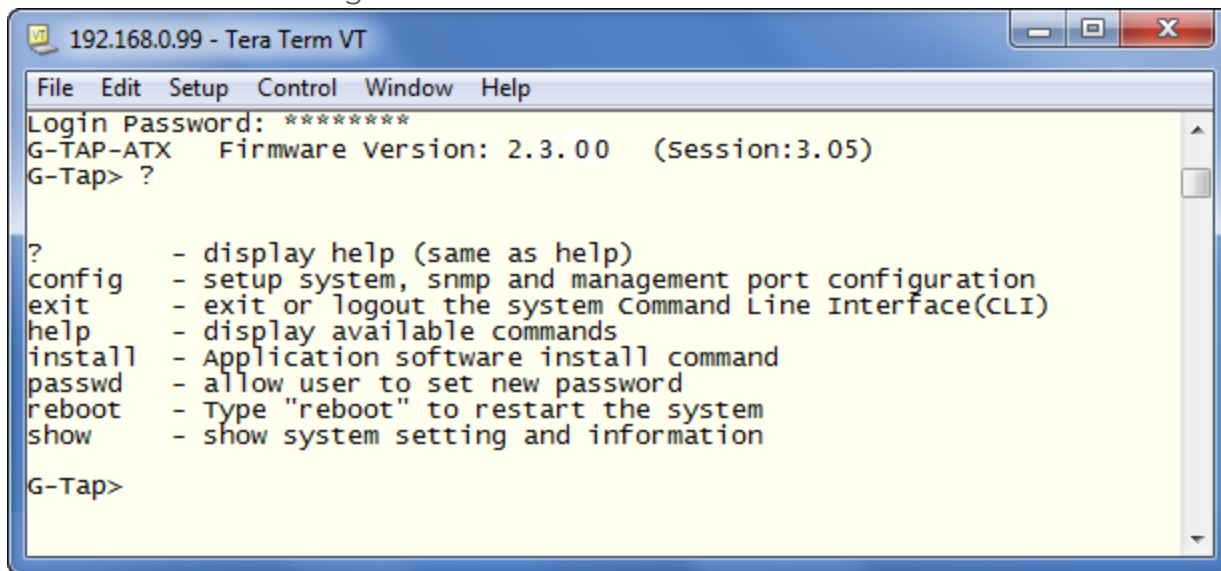

```

192.168.0.99 - Tera Term VT
File Edit Setup Control Window Help
Login Password: *****
G-TAP-ATX   Firmware Version: 2.3.00   (Session:3.05)
G-Tap> ?

?          - display help (same as help)
config    - setup system, snmp and management port configuration
exit      - exit or logout the system Command Line Interface(CLI)
help      - display available commands
install   - Application software install command
passwd    - allow user to set new password
reboot    - Type "reboot" to restart the system
show      - show system setting and information

G-Tap>

```

Command Line Basics

The G-TAP A Series command-line interface (CLI) provides a simple environment for configuring tap settings. Once you have logged in to the system, the CLI appears with the G-Tap > prompt. The basic G-TAP A Series commands are summarized in the following table:

Command	Description
? / help	Shows help on available commands.
BET	RUN <now 0 1 .. 90> SCHEDULE <disable auto random> Controls when to schedule the next BET. The RUN parameters specifies the number of days before the next test is run. If RUN is 0, the current BET is skipped

		<p>and the next BET runs according to the SCHEDULE parameter. The SCHEDULE parameter controls the periodicity of the next BET, as follows:</p> <ul style="list-style-type: none"> • disable – All future runs are disabled. • auto – All future BETs run within a 90 day period. • random – BET runs within the number of days specified by RUN plus r random number of days (where r is a value from 0 to 6), then run the BET within a 90 day period. Use the random parameter to make sure that BETs do not run at the same time when there is more than one G-TAP A Series.
brdtmp	Displays the current ambient board and battery temperature.	
config	[console_baud baud <9600 14400 19200 38400 57600 115200>]	Specifies the baud rate for the Console port
	[dhcp <1 0>]	Specifies whether the G-TAP A Series node will obtain an IP address for its Mgmt port from a DHCP server (1) or use a static address (0). If you set dhcp to 1 , do not supply values for ipaddr , subnetmask , or gateway .
	[dip_sw override <0 1>]	G-TAP A-TX Only

		<p>Specifies whether to use the DIP switches at the rear of the unit for configuration of Network/Monitor port physical settings or the CLI.</p> <ul style="list-style-type: none"> • enabled – Use the config port-params arguments to configure physical settings for Network/Monitor ports. • disabled – Use the DIP switches to configure physical settings for Network/Monitor ports. <p>Refer to Connect and Configure G-TAP A Series 1 Nodes</p>
	<pre>[ipaddr <addr> subnetmask <xxx.xxx.xxx.xxx>][gateway <xxx.xxx.xxx.xxxx>]</pre>	<p>Specifies the IP address, subnet mask, and default gateway for the Mgmt port. You only need to supply these values when dhcp is set to 0.</p>
	<pre>[port-params <port_name> <operations> <args>] [admin <0 1>] [lsp <0 1>] [autoneg <0 1>] [duplex <half full>] [speed <10 100 1000>]</pre>	<p>Configures network/monitor ports. You can configure different combinations of ports depending on the value specified for port_name, as follows:</p> <ul style="list-style-type: none"> • all • network • toolA • toolB

		<p>The available arguments are as follows:</p> <ul style="list-style-type: none"> • admin – Administratively disable/enable ports. You can enable/disable the network ports as a group or the tool ports individually (toolA/toolB). For example, the following command disables Tool Port A: config port-params toolA admin 0 • Arguments shown in blue are only available on the G-TAP A-TX and can only be used to configure ports when dip_sw override is enabled. <p>Refer to Connect and Configure G-TAP A Series 1 Nodes for details on how to use these arguments.</p>
config	[remote_timeout <10 ~ 604800>] (seconds)	<p>Specifies how long the G-TAP A Series node waits before timing out an inactive Telnet session. Valid values range from 10 to 86400 seconds. The default is 300 seconds.</p>
	[snmp_trap <args...>] [host <host_ip_addr>] [community <string>] [remove host <host_id>]	<p>Adds or deletes SNMP trap destinations . You can add up to four SNMP trap destinations, with each identified by a host_id from 0..3.</p>

		All available trap events are enabled when at least one SNMP Trap destination is configured with config snmp_trap host . Refer to Connect and Configure G-TAP A Series 1 Nodes for details on working with SNMP features.
	[taptx <active passive>]	G-TAP A-TX Only Opens and closes the relays in the G-TAP A-TX: <ul style="list-style-type: none"> • active – Relays are open. Traffic is sent to the Monitor/Tool ports. • passive – Relays are closed. Traffic flows through Network A/B ports only. <p>The default mode is active.</p>
	[telnet <0 1>]	Toggles the use of Telnet for the Mgmt port of the G-TAP A Series node.
	[time <hh:mm:ss>][date <mm-dd-yy>]	Sets the time and date for the G-TAP A Series node.
exit	Logs out of the CLI.	
install	Downloads a new application image from a TFTP server over the Mgmt port and installs it on the G-TAP A Series node.	

passwd	Changes the password on the G-TAP A Series node.
reboot	Reboots the G-TAP A Series node. The CLI gives you the option of performing a Warm or Cold reboot: <ul style="list-style-type: none"> • Warm Reboot – Network/Monitor ports are not affected. • Cold Reboot – Link connectivity interrupted until power restored and links re-established.
show	Shows current settings on the G-TAP A Series node. You can use this command with any of the following arguments: <ul style="list-style-type: none"> • batteryex – Shows the four last records of the BET. • diag – Provides detailed summary of current settings, operational parameters, and statistics. <p>Note: The show diag command reports CRC errors differently on the G-TAP A-TX and G-TAP A-SF taps:</p> <ul style="list-style-type: none"> • G-TAP A-TX: CRC errors for network ports are reported for diagnostic purposes. • G-TAP A-SF: CRC errors are not reported. • port-params – Shows Link, Auto Negotiation, Link Speed, and Duplex settings for the Network and Monitor ports. • G-TAP A-TX: dip_sw – Shows the current settings of the DIP switches on the rear of the tap. • snmp – Shows configured trap destinations and available trap events. • system – Shows detailed system configuration information, including network settings for the Mgmt port and the On/Off status of primary power sources. • time or date – Shows time/date configured on the G-TAP A Series node.

Command History

The G-TAP A Series 1 CLI remembers the last 10 commands you entered, allowing you scroll through previous commands with the up and down arrow keys.

Configure Network/Monitor Ports on the G-TAP A-TX

The G-TAP A-TX is shipped with autonegotiation enabled on the Network/Monitor ports and can be used out of the box by simply supplying power and connecting network cables. You can also set explicit speed/duplex parameters for the Network/Monitor ports using either the DIP switches at the rear of the unit (the default) or the CLI. You specify which method to use with the **config dip_sw override <0|1>** command, as summarized below:

config dip_sw override 0

Use the DIP switches at the rear of the G-TAP A-TX to configure physical settings for Network/Monitor ports. This is the default setting for the G-TAP A-TX node.

Refer to [Connect and Configure G-TAP A Series 1 Nodes](#)

config dip_sw override 1

Use the **config port-params** arguments to configure physical settings for Network/Monitor ports.

Refer to [Connect and Configure G-TAP A Series 1 Nodes](#)

Configure Port Settings with the DIP Switches (G-TAP A-TX)

When **config dip_sw override** is set to **0** (the default), you use the DIP switches at the rear of the G-TAP A-TX ([Connect and Configure G-TAP A Series 1 Nodes](#)) to set explicit speed/duplex parameters for the Network/Monitor ports.

Keep in mind that any changes to the DIP switches are immediately applied to the Network/Monitor ports and will momentarily interrupt data flow while the ports are reset. Use `show dip` and `show port-params` to see current DIP switch settings and negotiated speed/duplex settings.

NOTE: Only the G-TAP A-TX includes DIP switches for port configuration. There are no user-configurable settings for ports on the G-TAP A-SF, other than the ability to administratively enable/disable ports.

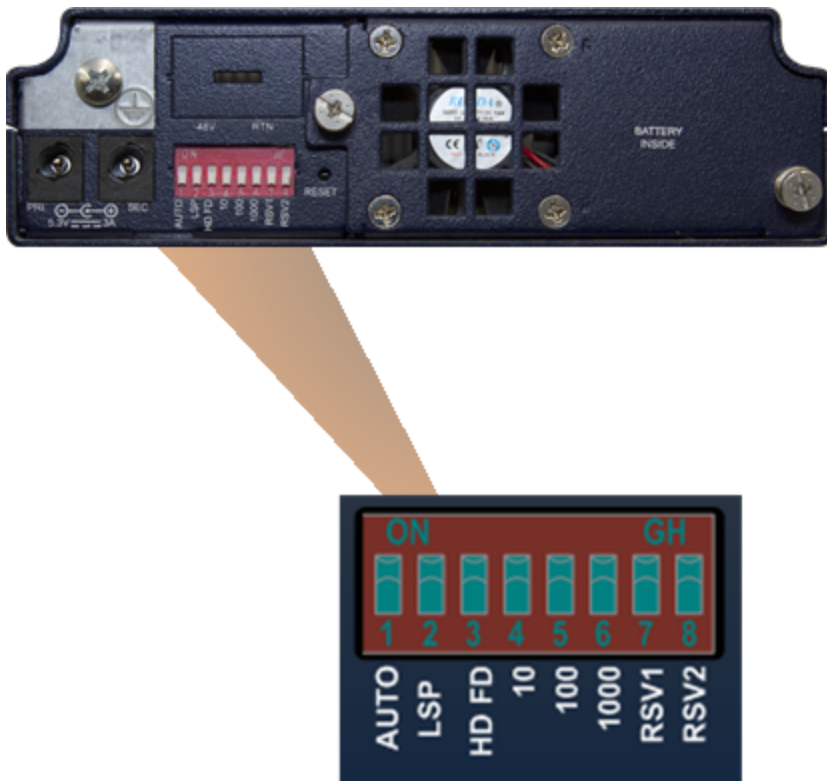

Configuring Network/Monitor Ports with DIP Switches

Bit/Switch	Description	
1 - AUTONEG	Autonegotiation – When set to On, Bits 3-6 are ignored and the Network Ports autonegotiate speed and duplex settings with the connected link. The Monitor/Tool ports use the speed negotiated by the Network Ports. Note that autonegotiation is also enabled if all DIP switches are set to the Off position.	
2 - LSP	Link State Propagation – When set to On, the G-TAP reacts to a link down event on one of the Network ports by forcing the other Network port down as well.	
3 - HD FD	Duplex Mode – When set to On, duplex is forced to Full.	Settings on DIP switches 3-6 apply to all Network/Monitor ports. If autonegotiation is disabled and more than one speed is selected (for example, switches 5 and 6 are both

4 - 10	10BASE-T – When set to On, link speed is forced to 10BASE-T (10Mbps).	On), the tap uses the highest selected speed.
5 - 100	100BASE-TX – When set to On, link speed is forced to 100BASE-TX (100Mbps).	
6 - 1000	1000BASE-T – When set to On, link speed is forced to 1000BASE-T (1Gbps).	
7 - RSV1	Reserved	
8 - RSV2		

Configure Port Settings in Software (G-TAP A-TX)

When **config dip_sw override** is set to **1**, you can use the **config port-params** command to configure autonegotiation, link state propagation, duplex, and speed settings for the network/monitor ports.

The syntax for the config port-params command is as follows:

Usage: config port-params <port_name> <operations> <0|1>

port_name can be:

<all>, <network>, <toolA>, or <toolB>

operations can be:

[admin <0 | 1>] [lsp <0 | 1>] [autoneg <0 | 1>] [duplex <half | full>] [speed <10 | 100 | 1000>]

Arguments for config port-params

Argument	Description
lsp	Link State Propagation – When enabled, the G-TAP A Series node reacts to a link down event on one of the Network ports by forcing the other Network port down as well.

autoneg	Autonegotiation – When enabled, the Network ports autonegotiate speed and duplex settings with the connected link. The Monitor/Tool ports use the speed negotiated by the Network Ports.
duplex	Duplex Mode – Specifies either half-duplex or full-duplex for the specified network/monitor ports.
speed	Speed – Sets the speed for the specified network/monitor ports to 10, 100, or 1000 Mbps.

Examples:

Command	Description
config port-params all lsp 1	Enables link status propagation on all network/monitor ports.
config port-params all speed 100	Sets the link speed to 100M on all network/monitor ports.

Configuring SNMP Trap Destinations

G-TAP A Series nodes can send SNMP v2 traps to a maximum of four destinations based on a wide variety of events on the system, including system reboots, changes in power status (On/Off), battery level changes, or link status changes on any Network/Monitor port.

Configure SNMP settings by specifying a maximum of four destinations for traps and a community string with the `config snmp_trap` command:

```
config snmp_trap [host <host_ip_addr>] [community <string>] remove <host_id>
```

For example, the following command specifies a trap destination of 192.168.1.25 with a community string of `gtap`:

```
config snmp_trap host 192.168.1.25 community gtap
```

The G-TAP A Series node automatically assigns a sequential Host ID to the new trap destination. You can use `config snmp_trap` with the `remove` argument to delete a host by specifying its Host ID. Use `show snmp` to see configured trap destinations along with their assigned IDs.

SNMP Trap Events

The G-TAP A Series supports the SNMP Trap events listed in the table below. You cannot enable traps individually—all traps are enabled when at least one SNMP Trap destination has been configured with **`config snmp_trap host`**.

The MIB for the G-TAP A Series is available for download from the company's standard FTP site. Contact Customer Support for details. Once you have received a copy of the MIB, you can compile and load it into your SNMP Management software to view descriptions of the OIDs included in the traps.

The events available for trapping are slightly different between the G-TAP A-TX and the G-TAP A-SF. The following table calls out the events specific to one tap or the other.

Trap	Description
System Reboot	Trap generated whenever the system reboots.
Power Source Status Change	Trap generated whenever the power source used by the tap changes (for example, from Primary AC to Battery).
Power Event Status Change	Trap generated whenever an AC, DC, or PoE power supply transitions from On to Off (or vice-versa).
Battery Level %	<p>Traps generated at 25% increments as the available battery charge falls - 75%, 50%, and 25%.</p> <p>The last Battery Level % trap is the generated when the available battery charge falls to 15%. Then, the A Series node takes the following action:</p> <ul style="list-style-type: none"> • G-TAP A-TX: The system closes the tap relays and falls back to passive mode with traffic flowing only across the Network ports when the battery level reaches 15%. • G-TAP A-SF: The G-TAP A-SF does not have relays. It keeps traffic flowing as long as it can with the power available. Once all power is exhausted, however, no traffic passes through the tap, either through the Network or Tool ports.
Battery Presence	<p>The Battery Presence trap is generated in two cases:</p> <ul style="list-style-type: none"> • The battery is not present. • The battery is installed in unit (recovery event).
Battery Exercise Started	Trap generated when the Battery Exercise Test (BET) starts.
Battery Exercise Ended	Trap generated when the BET ends.
Battery Exercise Missed	Trap generated when the BET did not occur as scheduled. The BET occurs every 90 days.
Hardware Problem During Battery Exercise	Trap generated if a hardware problem is encountered during the BET.
SOH	Trap generated when the battery State of Health (SOH) is below the

	predefined threshold.
Battery Temperature	The Battery Temperature trap is generated in two cases: <ul style="list-style-type: none"> • Extreme temperature conditions are detected for the battery. That is, the ambient temperature of the board is out of limit. • Recovery from extreme temperature conditions.
Board Temperature	The Board Temperature trap is generated in two cases: <ul style="list-style-type: none"> • Extreme temperature conditions are detected for the board. That is, the ambient temperature of the board is out of limit. • Recovery from extreme temperature conditions.
G-TAP A-TX: Network/Tool Port Link Speed Info	Trap generated whenever the speed of a Network/Tool port changes.
G-TAP A-TX: Network/Tool Port Link Status Change	Trap generated when the link status on any Network/Tool port transitions from Up to Down (or vice-versa). The trap indicates both the affected port and its speed.
G-TAP A-SF: Network/Tool Port Signal Detect Change	Trap generated whenever there is a change in the signal detected on any Network/Tool port (for example, light is detected on the ingress side of a port).

How to Use G-TAP A Series 1

This section describes how to tap a link with the G-TAP A-TX and G-TAP A-SF models. It also describes how to integrate an A Series 1 node with the G and H Series traffic visibility nodes that form your Gigamon visibility fabric.

Refer to the following sections for details:

- [Tap a Link with G-TAP A-TX](#)
- [Tap a Link with the G-TAP A-SF](#)
- [Connect G-TAP A Series 1 to GigaVUE Visibility Node](#)

Tap a Link with G-TAP A-TX

Tap a link with the G-TAP A-TX by disconnecting an existing link between two network devices (for example, the connection between an access switch and a distribution network) and reconnecting the link so that data flows through the tap ([How to Use G-TAP A Series 1](#)).

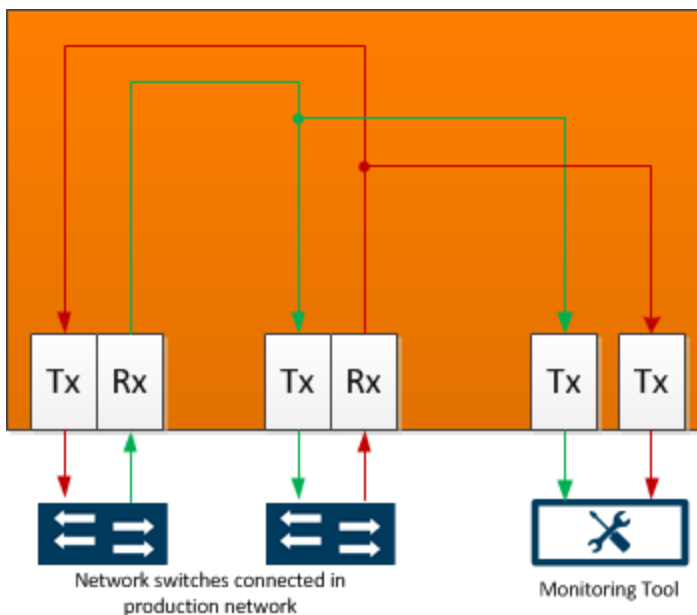

- G-TAP A-TX Data Flow

To tap a link with the G-TAP A-TX:

1. Connect test traffic to the Network A/B ports, close the tap relays with the config taptx passive command, and verify that traffic flows through the tap as expected
2. After verifying traffic flow in passive mode, switch back to active mode with config taptx active.
3. Use show port-params to verify that speed, duplex, and link state are correct.
4. With passive mode successfully tested, you can connect the production link. Connect the Ethernet cable from one network device to the Network A port.
5. Connect another cable from the second network device to the Network B port, making sure not to exceed the maximum combined cable length of 100 meters.
6. Connect the Monitor/Tool ports either to a network analysis tool or to a GigaVUE data access switch for intelligent distribution to multiple tools.

With the tap operating in Active mode, traffic is sent to the Monitor/Tool ports, as shown in [How to Use G-TAP A Series 1](#). The G-TAP A-TX automatically closes its relays and switches back to passive mode if all primary power sources are lost and the backup battery drops to 15 percent of charge capacity.

Power Loss and the G-TAP A-TX

The A Series implements Gigamon unique **Always-On** architecture, eliminating network link downtime through the use of primary power sources and a secondary on-board battery backup. Primary power sources charge the backup battery when it is at 95 percent of capacity, so it is ready to assume the power load in the event of a power failure on the primary sources. Charging stops when the battery is at 100 percent capacity.

When all primary power sources are lost, the on-board battery takes over, maintaining operations for up to one hour. SNMP traps are generated at 25 percent increments as the available battery charge falls to - 75%, 50%, and 25%.

The last **Battery Level %** trap is the generated when the available battery charge falls to 15%. At this point, the system closes the tap relays and falls back to passive mode with traffic flowing only across the Network ports. **Because of this, Gigamon recommends testing the tap in passive mode before deploying it on a production link.**

Blinking Link LEDs on G-TAP A-TX?

When autonegotiation is enabled, the G-TAP A-TX attempts to negotiate speed/duplex settings with the devices connected to the Monitor/Tool ports matching those already negotiated with the devices on the Network ports.

If the G-TAP A-TX is not able to negotiate a matching speed with the devices connected to the Monitor/Tool ports, it indicates the speed mismatch by blinking the Link LEDs on the affected Monitor/Tool port.

The devices connected to the Monitor/Tool ports must be capable of operating with the same speed/duplex settings used on the Network ports for successful traffic flow.

NOTE: If the devices connected to the Network ports are forced to 100Mbps Full Duplex and the G-TAP has autonegotiation enabled, the G-TAP A-TX falls back to 100Mbps Half Duplex as required by autonegotiation standards.

Tap a Link with the G-TAP A-SF

Tap a link with the G-TAP A-SF by disconnecting an existing link between two network devices (for example, the connection between an access switch and a distribution network) and reconnecting the link so that data flows through the tap.

As shown in the following figure, G-TAP A-SF data flow is as follows:

- Packets received on Network Port A are sent out Monitor/Tool Port A.
- Packets received on Network Port B are sent out Monitor/Tool Port B.

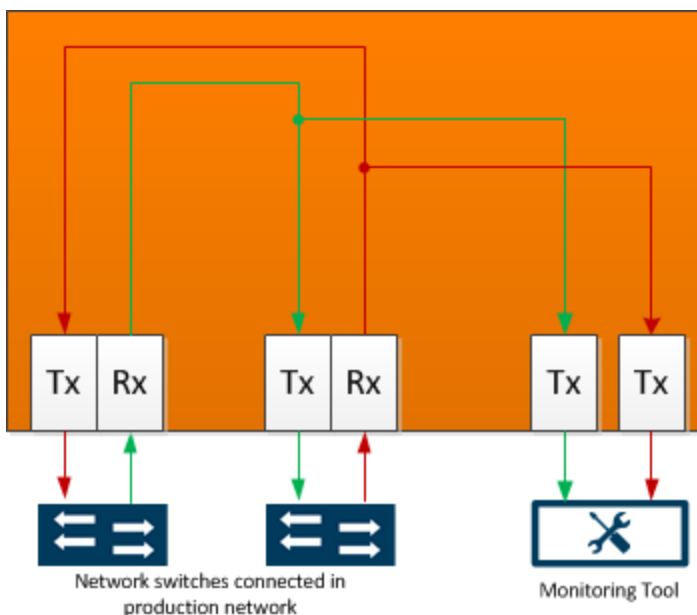

Power Loss and the G-TAP A-SF

The A Series implements Gigamon unique Always-On architecture, eliminating network link downtime through the use of primary power sources and a secondary on-board battery backup. Primary power sources charge the backup battery when it is at 95 percent of capacity, so it is ready to assume the power load in the event of a power failure on the primary sources. Charging stops when the battery is at 100 percent capacity.

When all primary power sources are lost, the on-board battery takes over, maintaining operations for up to one hour. SNMP traps are generated at 25 percent increments as the available battery charge falls to - 75%, 50%, and 25%.

The last **Battery Level %** trap is the generated when the available battery charge falls to 15 percent. The G-TAP A-SF keeps traffic flowing as long as it can with the power available. However, once all power is exhausted, no traffic passes through the tap, either through the Network or Tool ports.

G-TAP A-SF Transceiver Notes and Rules

The G-TAP A-SF supports **SFP** (SX/LX/ZX) and **SFP+** (SR/LR/ER/LRM) transceivers, as well as 1M and 5M **Direct Attach Cables** (SFP+ Copper) for connectivity to 1G/10G fiber and copper Ethernet links. For details on the transceivers supported for use with the G-TAP A-SF, refer to [G-TAP A-SF Transceiver Details on page 43](#).

Keep in mind the following notes and rules for transceivers used with the G-TAP A-SF:

- Always use transceivers purchased from Gigamon to ensure interoperability and performance.
- Tap speed is determined by the external devices connected to the Network ports. The external devices must be running at the same speed for data to be passed to the Monitor/Tool ports.
- Both Network ports must use the same transceiver type (for example, an SX SFP in Network A and an SX SFP in Network B).
- The Tool port transceivers must support the same speed as the Network port transceivers. However, the Tool port transceivers do not need to be the same medium, either as one another or as those in the Network ports.

For example, if the network ports both use 1G multimode fiber transceivers, you could use a 1G single-mode fiber transceiver in Tool Port A and a 1G copper SFP transceiver in Tool Port B. This is summarized in the following table:

Network Port A	Network Port B	Tool Port A	Tool Port B
1G SFP MM	1G SFP MM	1G SFP SM	1G SFP Copper

- When using 1G SFP Optical Transceivers in the Monitor/Tool ports, the connected tools must have autonegotiation disabled for the link to establish successfully.
- Copper SFP transceivers can only be used at 1G speeds (1000BASE-T). There are no configurable autonegotiation, speed, or duplex settings for these transceivers that would allow 10/100 Mbps use.

Sample Transceiver Combinations

[How to Use G-TAP A Series 1](#) lists some sample combinations of transceivers supported by the G-TAP A-SF. Note the following in each of these combinations:

- The Network Port transceivers always match both speed and medium.
- The Tool Port transceivers always run at the same speed as the Network Port transceivers. However, they do not necessarily need to match the medium either of the Network Port transceivers or of one another.

These are only samples – so long as the Network port transceivers match speed and medium and the tool port transceivers can support the speed used by the external devices, the combination works. However, if the network port transceivers are using copper medium, the tool port transceivers must also use copper medium.

Transceiver Combinations for G-TAP A-SF			
1G SFP Cu	1G SFP Cu	1G SFP Cu	1G SFP Cu
1G SFP MM	1G SFP MM	1G SFP MM	1G SFP MM
1G SFP SM	1G SFP SM	1G SFP SM	1G SFP SM
10G SFP MM	10G SFP MM	10G SFP MM	10G SFP MM
10G SFP SM	10G SFP SM	10G SFP SM	10G SFP SM
10G Direct Attach	10G Direct Attach	10G Direct Attach	10G Direct Attach

View Port Parameters

Use the **show port-params** command in the G-TAP A Series command-line interface to view the current settings used by the transceivers in the G-TAP A-SF Network and Monitor/Tool ports.

For example, the following sample CLI output shows matching SFP+ transceivers in the Network ports, while one Monitor/Tool port has an SFP and the other is empty:

```
G-Tap> show port-params
```

Parameter	NETWORK		MONITOR	
	Port A	Port B	Port A	Port B
Admin:	1	1	1	1
Signal Detect:	1	1	0	0
Tx Power(dBm):	n/a	n/a	-5.18	n/a
Rx Power(dBm):	n/a	n/a	--	n/a
SFP Module Type:	SFP+ PDCBL	SFP+ PDCBL	SFP SX	--
Cable Length(m):	1	1	n/a	n/a

Connect G-TAP A Series 1 to GigaVUE Visibility Node

Connect the G-TAP A Series 1 to a GigaVUE traffic visibility node to take advantage of powerful GigaVUE traffic distribution features. You can connect any G-TAP A Series model to ports using matching media on a G or H Series GigaVUE traffic visibility node (fiber-to-fiber or copper-to-copper).

In this example, the Network A and Network B ports on the G-TAP A-SF are connected to ports on a module in a GigaVUE-HC3. Data passing through the G-TAP A Series is available for intelligent distribution throughout the Gigamon visibility fabric using standard GigaVUE packet distribution techniques (maps/xbmaps, connects/xbconnects, and pass-alls). In addition, traffic received on one Network port is actively regenerated out the other Network port.

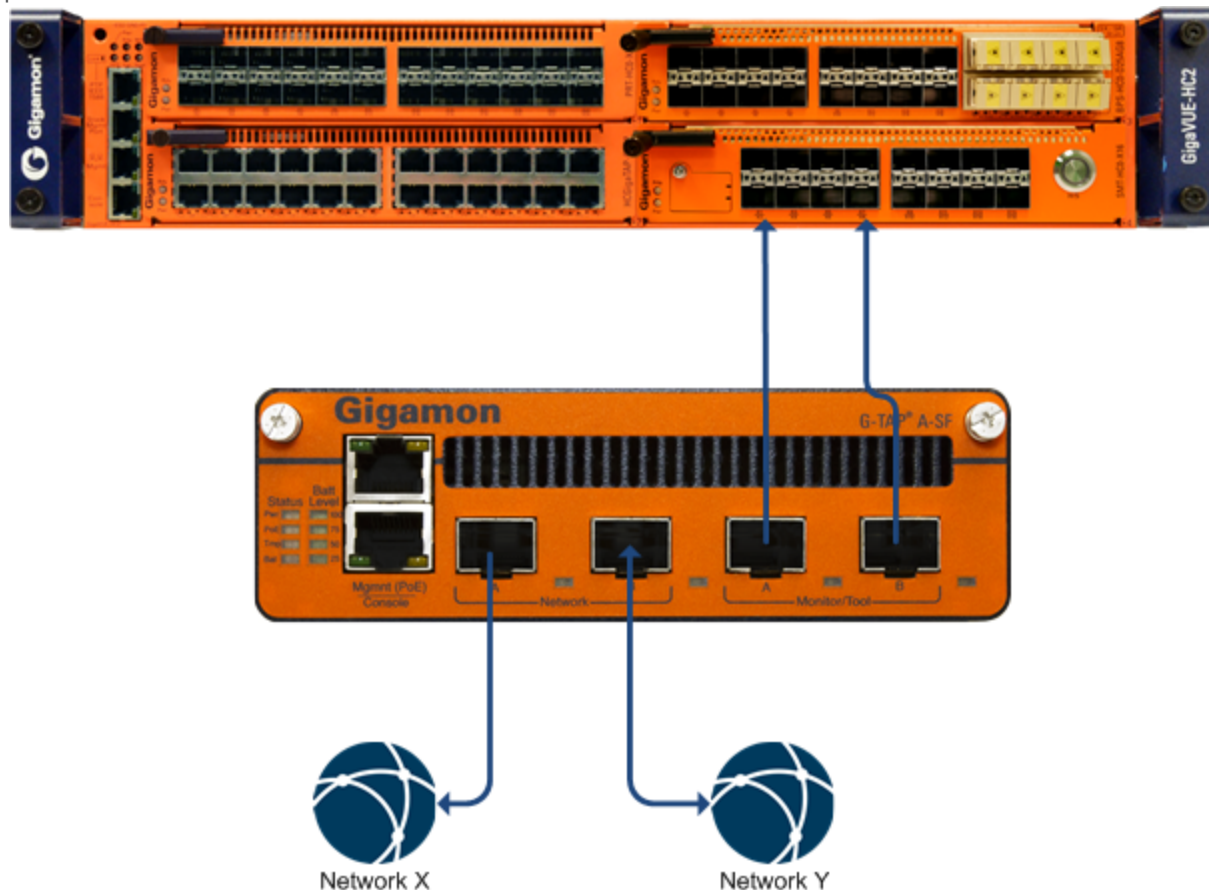

Using the G-TAP with the Gigamon Visibility Fabric

G-TAP A-SF Transceiver Details

This section provides details on the optical transceivers supported for use with the G-TAP A-SF node. Refer to the following sections for details:

- [G-TAP A-SF Transceiver Details](#)
- [How to Identify SFP/SFP+ Transceivers](#)
- [SFP/SFP+ Transceiver Operating Specifications](#)

G-TAP A-SF Transceiver Details

The following table lists the Gigamon transceivers supported for use with the G-TAP A-SF.

Important: Always use transceivers purchased from Gigamon to ensure interoperability and performance.

Supported Transceivers

Transceiver Type	Part Number	Description
SFP (1G)	SFP-501	1 Gig SFP, Copper, UTP with RJ-45 interface
	SFP-502	1 Gig SFP, Multimode 850
	SFP-503	1 Gig SFP, Singlemode 1310
SFP+ (10G)	SFP-532	10 Gig SFP+, Multimode 850nm SR
	SFP-533	10 Gig SFP+, Singlemode 1310nm LR
	SFP-534	10 Gig SFP+, Singlemode 1550nm ER (Special Order)
	SFP-535	10 Gig SFP+, Multimode 1310nm LRM (Special Order)

How to Identify SFP/SFP+ Transceivers

It is not always easy to tell the difference between various SFP+/SFP transceivers. Use the following tips to keep track of your transceivers:

- SFP+ transceivers use **metal** bail and latch assemblies. The color of the metal bail corresponds to the SFP+ type, as summarized in [G-TAP A-SF Transceiver Details](#).
- 1G SFP transceivers use either bail and latch assemblies with a colored plastic sheath around the bail or assemblies made entirely of plastic (Sx SFP). The color of the plastic sheath corresponds to the SFP type, as summarized in [G-TAP A-SF Transceiver Details](#).

Media/Transceiver Descriptions



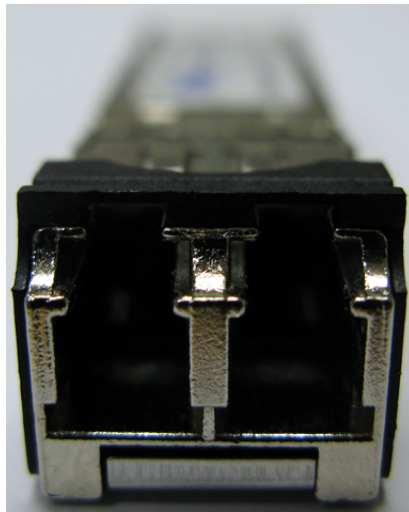

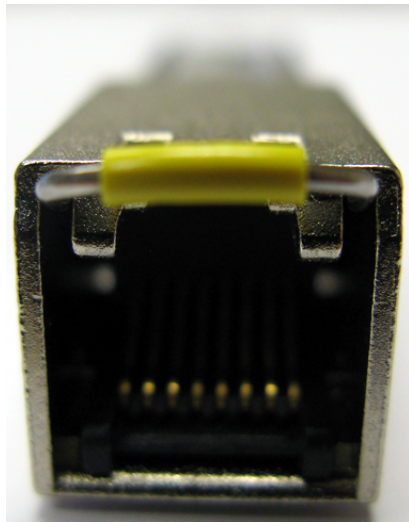
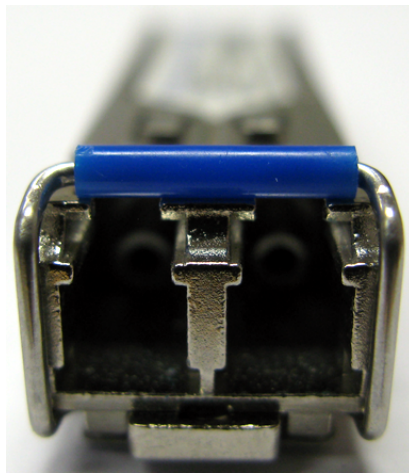

SFP/SFP+ Transceiver Operating Specifications

[G-TAP A-SF Transceiver Details](#) summarizes the operating characteristics of the SFP/SFP+ transceivers supported for use with the G-TAP A-SF. Keep in mind the following important notes regarding the information in the table:

	Launch power and sensitivity values provided here are for reference only.
	Multi-mode distance shown in the tables below is dependent on the cable's modal bandwidth. See your cable manufacturer's specifications for detailed information.
	Multi-mode fibers can be 62.5/125 or 50/125. Mixing different fiber types can cause link distance to degrade.

Transceiver Specifications							
Type		<i>G-TAP A-SF Transceiver Details</i>	<i>G-TAP A-SF Transceiver Details</i>				
SFP	850 (SX)	200-550m	Multi-mode fiber	LC	-9.5	-17	
	1310 (LX)	10km	Single-mode fiber	LC	-9.5	-19	
	CAT5 Copper (SFP Copper)	100m	UTP CAT-5 or better	RJ45	N/A	N/A	
SFP+	850 (SR)	300m	Multi-mode fiber	LC	-7.3	-11.1	
	1310 (LR)	10km	Single-mode fiber	LC	-5.2 (OMA)	-12.6 (OMA)	
	1310 (LRM)	220m	Multi-mode fiber	LC	-4.5	-6.5	1310nm on multi-mode Special order
	1550 (ER)	40km	Single-mode fiber	LC	-1.7	-11.3	Special order
	SFP+ Direct Attach (SFP+ Copper)	1m (30 AWG Max)5m (26 AWG Max)	SFP+ Direct Attach Copper	SFP+	N/A	N/A	

Additional Sources of Information

This appendix provides additional sources of information. Refer to the following sections for details:

- [Documentation](#)
- [Documentation Feedback](#)
- [Contact Technical Support](#)
- [Contact Sales](#)
- [The VÜE Community](#)

Documentation

This table lists all the guides provided for GigaVUE A Series software and hardware. The first row provides an All-Documents Zip file that contains all the guides in the set for the release.

NOTE: In the online documentation, view [What's New](#) to access quick links to topics for each of the new features in this Release; view [Documentation Downloads](#) to download all PDFs.

Table 1: Documentation Set for Gigamon Products

GigaVUE A Series 2.3.01 and above Hardware and Software Guides
DID YOU KNOW? If you keep all PDFs for a release in common folder, you can easily search across the doc set by opening one of the files in Acrobat and choosing Edit > Advanced Search from the menu. This opens an interface that allows you to select a directory and search across all PDFs in a folder.
Hardware how to unpack, assemble, rackmount, connect, and initially configure ports the respective GigaVUE A Series devices; reference information and specifications for the respective GigaVUE A Series devices
GigaVUE-HC1 Hardware Installation Guide
GigaVUE-HC3 Hardware Installation Guide
GigaVUE-HC1-Plus Hardware Installation Guide
GigaVUE-HCT Hardware Installation Guide
GigaVUE-TA25 Hardware Installation Guide
GigaVUE-TA25E Hardware Installation Guide
GigaVUE-TA100 Hardware Installation Guide

GigaVUE A Series 2.3.01 and above Hardware and Software Guides	
GigaVUE-TA200 Hardware Installation Guide	
GigaVUE-TA200E Hardware Installation Guide	
GigaVUE-TA400 Hardware Installation Guide	
GigaVUE-OS Installation Guide for DELL S4112F-ON	
G-TAP A Series 2 Installation Guide	
GigaVUE M Series Hardware Installation Guide	
GigaVUE-FM Hardware Appliances Guide	
Software Installation and Upgrade Guides	
GigaVUE-FM Installation, Migration, and Upgrade Guide	
GigaVUE-OS Upgrade Guide	
GigaVUE V Series Migration Guide	
Fabric Management and Administration Guides	
GigaVUE Administration Guide	covers both GigaVUE-OS and GigaVUE-FM
GigaVUE Fabric Management Guide	how to install, deploy, and operate GigaVUE-FM; how to configure GigaSMART operations; covers both GigaVUE-FM and GigaVUE-OS features
Cloud Guides	
how to configure the GigaVUE Cloud Suite components and set up traffic monitoring sessions for the cloud platforms	
GigaVUE V Series Applications Guide	
GigaVUE V Series Quick Start Guide	
GigaVUE Cloud Suite Deployment Guide - AWS	
GigaVUE Cloud Suite Deployment Guide - Azure	
GigaVUE Cloud Suite Deployment Guide - OpenStack	
GigaVUE Cloud Suite Deployment Guide - Nutanix	
GigaVUE Cloud Suite Deployment Guide - VMware (ESXi)	
GigaVUE Cloud Suite Deployment Guide - VMware (NSX-T)	
GigaVUE Cloud Suite Deployment Guide - Third Party Orchestration	
Universal Cloud TAP - Container Deployment Guide	

GigaVUE A Series 2.3.01 and above Hardware and Software Guides

Gigamon Containerized Broker Deployment Guide

GigaVUE Cloud Suite Deployment Guide - AWS Secret Regions

GigaVUE Cloud Suite Deployment Guide - Azure Secret Regions

Reference Guides

GigaVUE-OS CLI Reference Guide

library of GigaVUE-OS CLI (Command Line Interface) commands used to configure and operate GigaVUE HC Series and GigaVUE TA Series devices

GigaVUE-OS Security Hardening Guide

GigaVUE Firewall and Security Guide

GigaVUE Licensing Guide

GigaVUE-OS Cabling Quick Reference Guide

guidelines for the different types of cables used to connect Gigamon devices

GigaVUE-OS Compatibility and Interoperability Matrix

compatibility information and interoperability requirements for Gigamon devices

GigaVUE-FM REST API Reference in GigaVUE-FM User's Guide

samples uses of the GigaVUE-FM Application Program Interfaces (APIs)

Release Notes

GigaVUE-OS, GigaVUE-FM, GigaVUE-VM, G-TAP A Series, and GigaVUE Cloud Suite Release Notes

new features, resolved issues, and known issues in this release ;
important notes regarding installing and upgrading to this release

NOTE: Release Notes are not included in the online documentation.

NOTE: Registered Customers can log in to [My Gigamon](#) to download the Software and Release Notes from the Software and Docs page on to [My Gigamon](#). Refer to [How to Download Software and Release Notes from My Gigamon](#).

In-Product Help

GigaVUE-FM Online Help

how to install, deploy, and operate GigaVUE-FM.

How to Download Software and Release Notes from My Gigamon

Registered Customers can download software and corresponding Release Notes documents from the **Software & Release Notes** page on to [My Gigamon](#). Use the My Gigamon Software & Docs page to download:

- Gigamon Software installation and upgrade images,
- Release Notes for Gigamon Software, or
- Older versions of PDFs (pre-v5.7).

To download release-specific software, release notes, or older PDFs:

1. Log in to [My Gigamon](#).
2. Click on the **Software & Release Notes** link.
3. Use the **Product** and **Release** filters to find documentation for the current release. For example, select Product: "GigaVUE-FM" and Release: "5.6," enter "pdf" in the search box, and then click **GO** to view all PDF documentation for GigaVUE-FM 5.6.xx.

NOTE: My Gigamon is available to registered customers only. Newer documentation PDFs, with the exception of release notes, are all available through the publicly available online documentation.

Documentation Feedback

We are continuously improving our documentation to make it more accessible while maintaining accuracy and ease of use. Your feedback helps us to improve. To provide feedback and report issues in our documentation, send an email to:

documentationfeedback@gigamon.com

Please provide the following information in the email to help us identify and resolve the issue. Copy and paste this form into your email, complete it as able, and send. We will respond as soon as possible.

Documentation Feedback Form		
About You	Your Name	
	Your Role	
	Your Company	

For Online Topics	Online doc link	<i>(URL for where the issue is)</i>
	Topic Heading	<i>(if it's a long topic, please provide the heading of the section where the issue is)</i>
For PDF Topics	Document Title	<i>(shown on the cover page or in page header)</i>
	Product Version	<i>(shown on the cover page)</i>
	Document Version	<i>(shown on the cover page)</i>
	Chapter Heading	<i>(shown in footer)</i>
	PDF page #	<i>(shown in footer)</i>
How can we improve?	Describe the issue	<i>Describe the error or issue in the documentation. (If it helps, attach an image to show the issue.)</i>
	How can we improve the content? Be as specific as possible.	
	Any other comments?	

Contact Technical Support

For information about Technical Support: Go to **Settings**  **> Support > Contact Support** in GigaVUE-FM.

You can also refer to <https://www.gigamon.com/support-and-services/contact-support> for Technical Support hours and contact information.

Email Technical Support at support@gigamon.com.

Contact Sales

Use the following information to Gigamon channel partner or Gigamon sales representatives.

Telephone: +1.408.831.4025

Sales: inside.sales@gigamon.com

Partners: www.gigamon.com/partners.html

Premium Support

Email Gigamon at inside.sales@gigamon.com for information on purchasing 24x7 Premium Support. Premium Support entitles you to round-the-clock phone support with a dedicated Support Engineer every day of the week.

The VÜE Community

The [VÜE Community](#) is a technical site where Gigamon users, partners, security and network professionals and Gigamon employees come together to share knowledge and expertise, ask questions, build their network and learn about best practices for Gigamon products.

Visit the VÜE Community site to:

- Find knowledge base articles and documentation
- Ask and answer questions and learn best practices from other members.
- Join special-interest groups to have focused collaboration around a technology, use-case, vertical market or beta release
- Take online learning lessons and tutorials to broaden your knowledge of Gigamon products.
- Open support tickets (Customers only)
- Download the latest product updates and documentation (Customers only)

The VÜE Community is a great way to get answers fast, learn from experts and collaborate directly with other members around your areas of interest.

Register today at community.gigamon.com

Questions? Contact our Community team at community@gigamon.com.